

Spec Guide

ZipTwo® | Micro 3508 | Ceiling Cable | 707

Direct lighting for open office, wall wash and grazing applications.



Micro 3508, 120° Symmetric, white

Benefits & Features

Micro Profile, Robust Design

Flat profile. 1.38" (35mm) x 0.31" (8mm).

Superior Light Quality & Performance

Output up to 1583 lm/ft (5192 lm/m) (HO). 80 or 90 CRI & tunable white (2200K-5000K) available.

Adaptive Power Body

Full range dimming power for all protocols. Integral or remote power available. Remote power available up to 100' (30.5m) away.

Better Optics & Beam Control

Options of Diffuse, 120°, 60°, 40° and 85° (asymmetric) lens for general illumination, grazing or wall wash. Excellent glare control with optical film and MicroBaffle™.

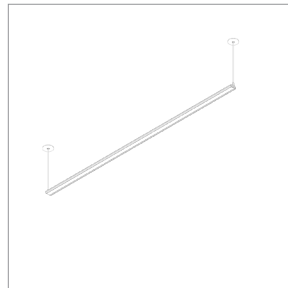

Small Round Canopy

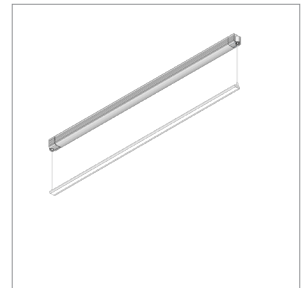

Integral Power

Build Your Specification

707-Z2	S			CC	0	»
--------	---	--	--	----	---	---

System & Rail Type	System Type	System Length	Rail Length	Mounting	Arm/Cord Length
707-Z2 ZipTwo	S Suspended	Specify overall system length in ft/in or M/mm. <i>Corners and Shapes Available. See Corners and Shapes Guide for more details.</i>	24 24" (610mm) 36 36" (914mm) 48 48" (1219mm) 60 60" (1524mm) 72 72" (1829mm) 96 96" (2438mm) 108 108" (2743 mm) 120 120" (3048 mm) 132 132" (3352 mm) 144 144" (3658 mm) ZZ Other rail length or layout (please specify)	CC Ceiling Cable	48 48" cord (1219mm) 96 96" cord (2438mm) ZZ Other (please specify)

See [Rail Length Chart](#) for more details

»				0	Z	»
---	--	--	--	---	---	---

Power Location	Power Type	Voltage	Emergency Power	LED Type
Integral Power IP Integral Power Small Round Canopy 2R25 25' (76.2m) Wire Harness 2R50 50' (15.24m) Wire Harness 2R75 75' (22.9m) Wire Harness 2R100 100' (30.5m) Wire Harness	Flexible 1 to 1 Power AE eldoLED 0-10v, 1.0% Dimming AT eldoLED 0-10v, 0.1% Dimming AD eldoLED DALI, 0.1% Dimming AX eldoLED DMX, 100-0.1% Dimming AH Hi-lume 1% EcoSystem, Soft On / Fade to Black Technology, LDE1 AH2 Hi-lume 1% 2-wire LTEA2W (120V forward phase only) Optimized Power AEO eldoLED 0-10v, 1.0% Dimming ATO eldoLED 0-10v, 0.1% Dimming ADO eldoLED DALI, 0.1% Dimming AXO eldoLED DMX,100-0% dimming ZZ Other (please specify)	1 120v 2 120v-277v X Not Yet Specified	0 No Emergency Power ZZ Emergency Power <i>(specify requirements)</i>	Z Zipper Board™ ZZ Zipper Board™

**See [Power Guide](#) for driver features & limitations.*

»				0
---	--	--	--	---

Lumen Output	Color Temperature	Optics	Sensors
LO Low Output SO Standard Output HO High Output ¹ ZZ Other (please specify) <i>See IES Files page for details. *See Power Guide for driver features & limitations.</i>	80+ CRI 27 2700K 30 3000K 35 3500K 40 4000K 90+ CRI 279 2700K 309 3000K 359 3500K 409 4000K ZZ Tunable White Available <i>See Guide for details</i>	A1 Micro 3508, 85° Asymmetric S1 Micro 3508, 40° Symmetric S2 Micro 3508, 60° Symmetric S3 Micro 3508, 120° Symmetric D3 Micro 3508, High Lumen ¹ D4 Micro 3508, High Lumen with MicroBaffle ¹	0 None ZZ Other (please specify) ²

»	
---	--

Finish	Options
WH White	0 None
BL Black	9 9' 18/3 Cord and Plug

NOTES & LIMITATIONS

¹ High Lumen (D3) and High Lumen with MicroBaffle (D4) are only available in White Finish (WH).

²Sensors available. Contact **Vode** for more information.

Contact factory for Chicago Plenum

5 Year Limited Warranty. See full Vode warranty description [here](#) or at [vode.com](#).

Listed to UL standards for damp location by a Nationally Recognized Testing Laboratory (NRTL) recognized by OSHA.



Applications

General Interior and Open Office

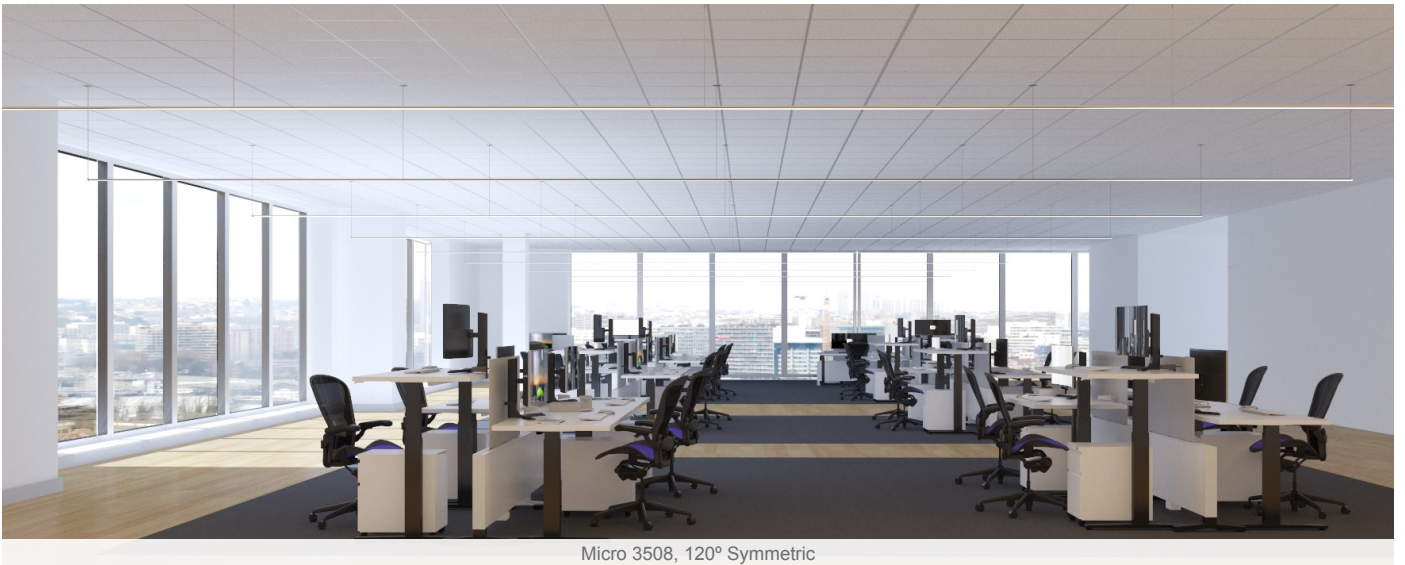

Structure

Rail Lengths	24" (610mm) - 144" (3658mm) See Rail Length Chart for more details
Rail Dimensions	1.38" (35mm) x 1.0" (25mm). See dimensions section, page 8 , for details
Construction	Extruded and machined 6063 aluminum
Mounting	Ceiling mount to jbox or driver housing
Cable Length	48" (1220mm) and 96" (2438mm) available. Field adjustable. Non-standard cable lengths available.
System Run Length	24" (610mm) minimum. Unlimited maximum length
Operating Temperature	32°F to 104°F (0°C to 40°C)
Humidity	0-85%, non-condensing
System Weight	0.25 lbs per foot (0.11 kg per 305mm) power supply and housing not included

Materials

LED Board Construction	Aluminum core PCB, black LCP connectors, RoHS compliant
Lens	High-impact extruded acrylic glass (PMMA).
Suspension Cable	Ø4mm, 22/4 AWG, TPE jacket, FEP-insulated, Red List Approved
Power Cable	Ø3mm, 33/2 AWG, Plenum (CMP) rated semi-rigid PVC or FEP, flame tested UL-910, Red List Approved
Cable Connectors	Unfilled black nylon, rated UL 94 V-0, halogen free, PVC or FEP overmold, RoHS compliant, Red List Approved.
Remote Linear Power Housing	20.7" x 2.375" x 2.53", 0.054" formed Galvanized Steel.
Remote Brick Power Housing	4.32" x 3.37" x .078" Galvanized Steel mounting plate
Integral Power Housing	extruded and machined 6063 aluminum
Center Cable Suspension	3/64" aircraft cable

Mounting Options

Remote Power

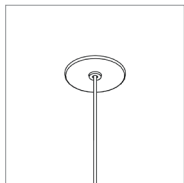

Small Round Canopy
Ø2.5" (51mm)

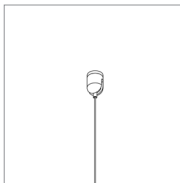

Center Support Cable
108" - 144" Rails Only
Center Support Cable for mounting to T-Bar tile available.

Integral Power (24"-72")

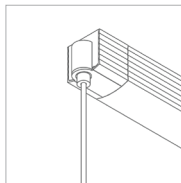

Integral Power (end)
h 1.8" (46mm)
w 1.7" (43mm)

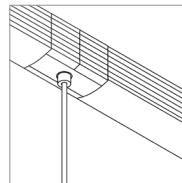

Integral Power (joint)

24" - 96" Rail Dimensions

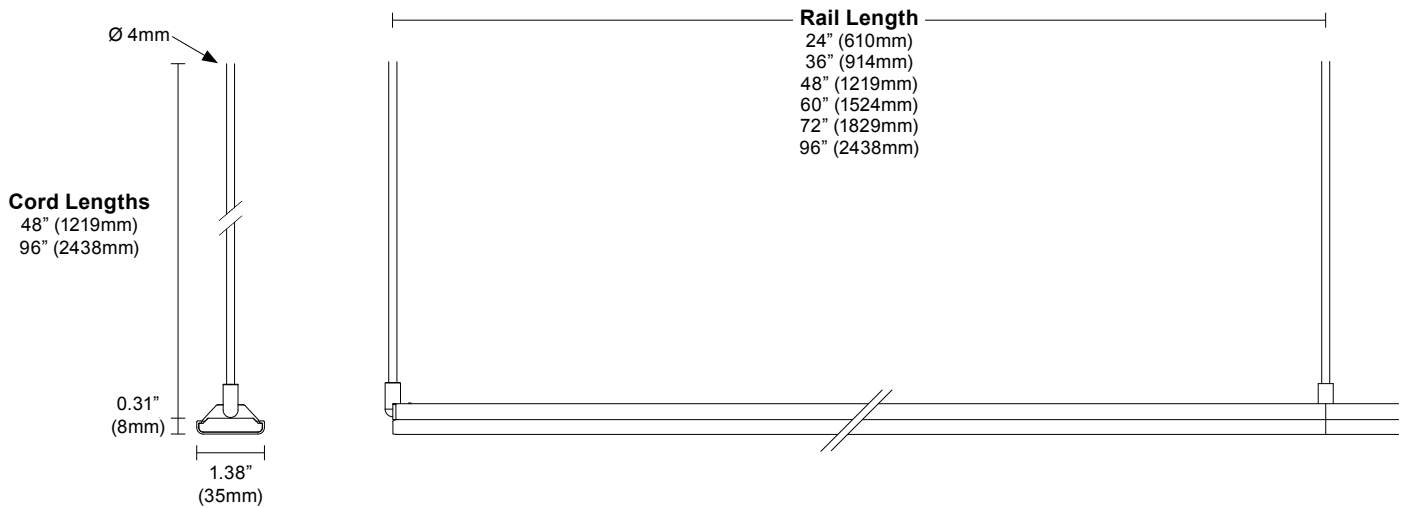

Layout

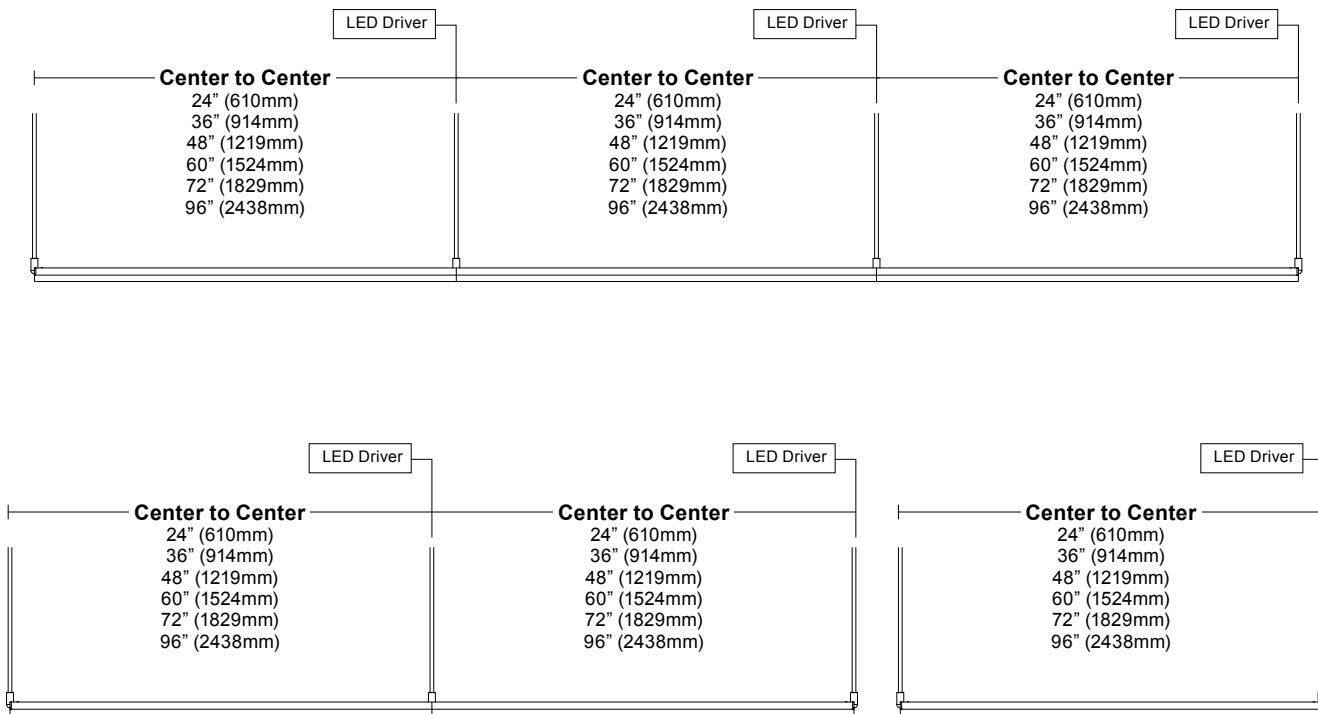

Corner and Shapes Available. See [Corners and Shapes Guide](#).

108" - 144" Rail Dimensions

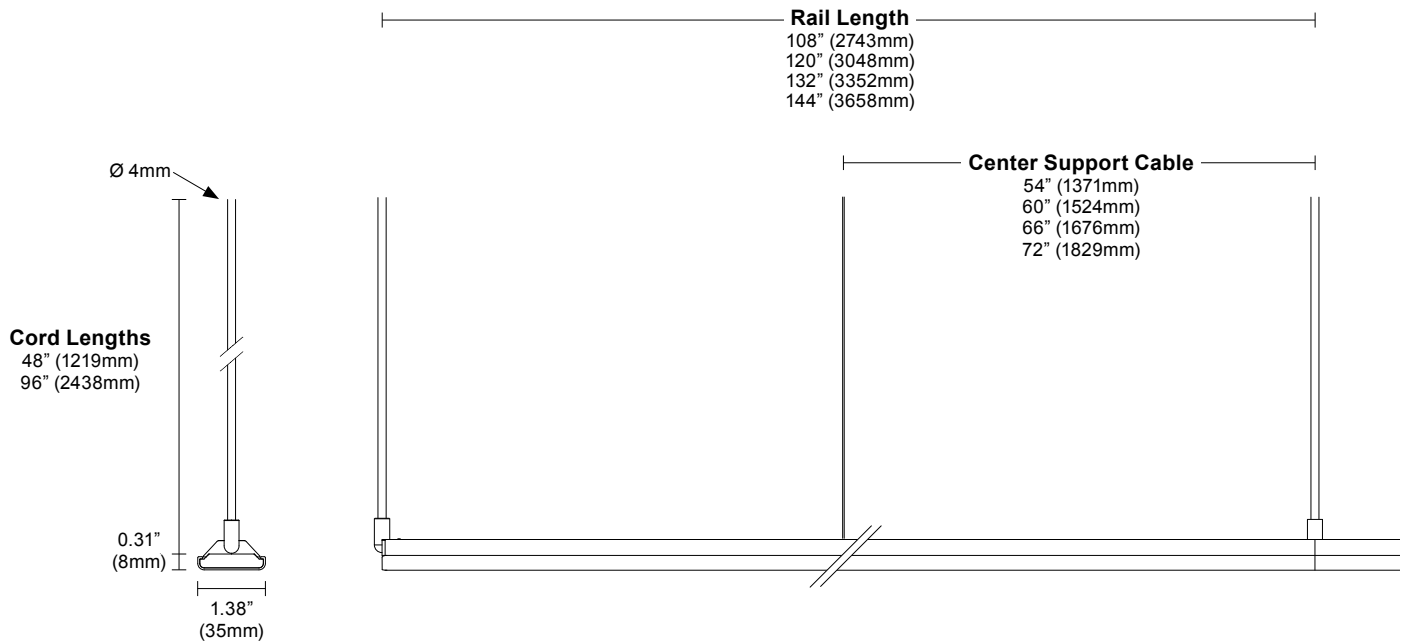

Layout

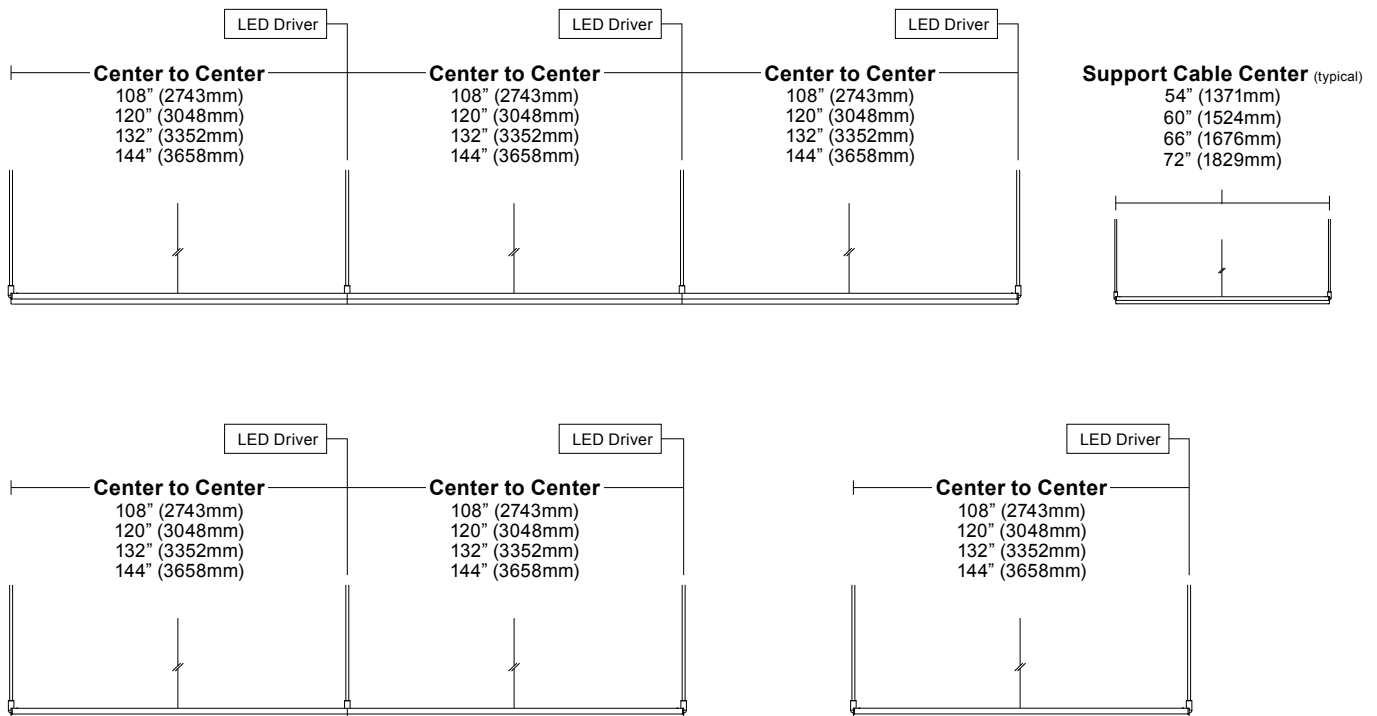

Corner and Shapes Available. See [Corners and Shapes Guide](#).

Power and Controls

Power Type	Class 2 (<60v output) constant current driver
Dimming Controls	Dimming (0.1%, 1%), 0-10v, DALI, DMX, Lutron Hi-lume 1% are available. See Power Guide for details.
Input Voltage	120v - 277v, 50/60hz
Power Location	Remote power. Maximum remote distance up to 100' (30.5m) depending on driver selection. See Power Guide for details.

Remote power is locating the power supply away from the fixture. Remote power comes in two housing styles: brick style and linear style. Consult [Power Guide](#) to determine which type you will receive.

Remote Brick Power Housing

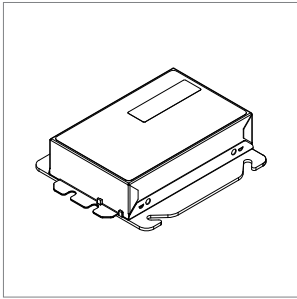

Supplied for some remote power applications. One remote power supply housing is supplied for each rail. Provided driver mounting plate fits standard 4" metal, square J-Boxes with a minimum volume of 21 in³ (J-Box not provided). See [Tech Sheet](#) for details.

Remote Linear Power Housing

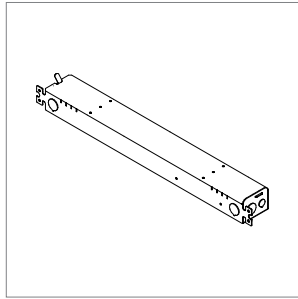

One remote power supply housing is supplied with each power supply. All Vode linear remote drivers come in a 0.054" (0.8mm) formed galvanized steel power supply housing with five (5) knockouts: (4) 1-1/8", (1) 7/8" and (1) 9/16". Accommodates standard linear power supplies. See [Tech Sheet](#) for details.

Integral Power

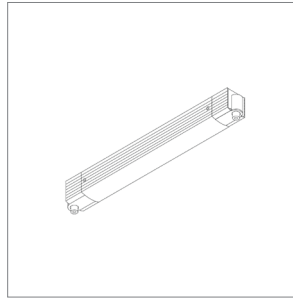

Houses integral power supply. Direct conduit feed is recommended, but integral power supply housing will mount to any standard North America 4" j-box. Mounts to most surfaces. Blocking is recommended at all arm junctions. See [Tech Sheet](#) for details.

Wire Harness

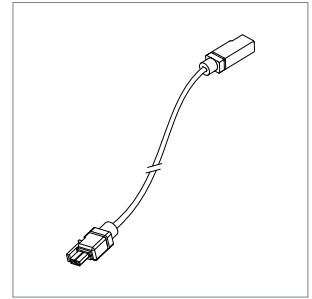

Wire harness connects driver to rail. Wire harness is 25' (7.6m) with micro fit molex connectors for quick and easy installation. Wire harnesses are also available in 50' (15m), 75' (22.9m), and 100' (30.5m). See [Tech Sheet](#) for details.

Power and Controls

Flexible 1 to 1 power

For Flexible 1 to 1 Power, Vode supplies one single output driver per fixture, allowing each fixture to be controlled independently. Direct/Indirect fixtures are supplied with two single output drivers, allowing the direct and indirect lighting to be controlled independently. Consult [Power Guide](#) to determine which type you will receive.

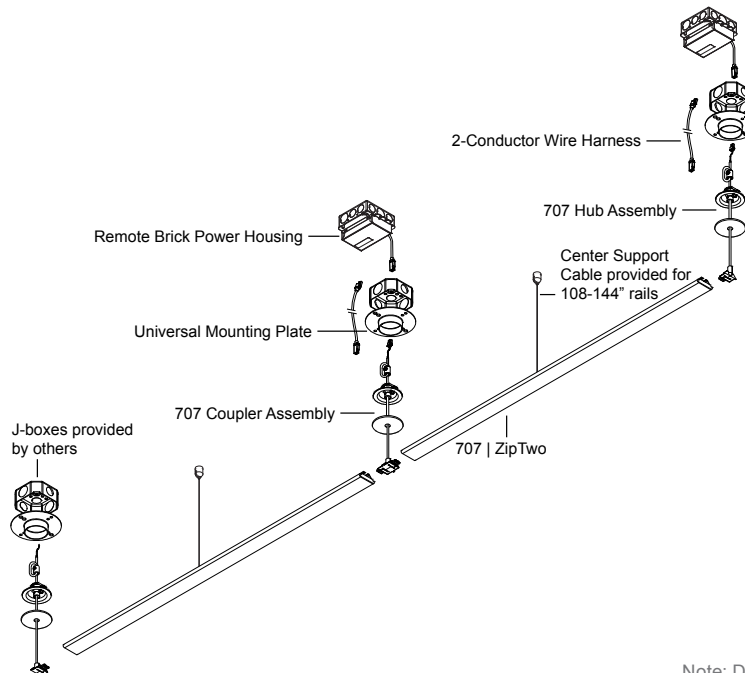

Note: Drawings not to scale, for reference only.

Optimized Power

To optimize power, Vode configures specifications with drivers that have 2 or 4 outputs. Depending on system configurations and power requirements, up to 4 fixtures can be powered from a 4-output driver. Consult [Power Guide](#) to determine which type you will receive.

IMPORTANT: Each fixture will still require individual wire harnesses, as shown below.

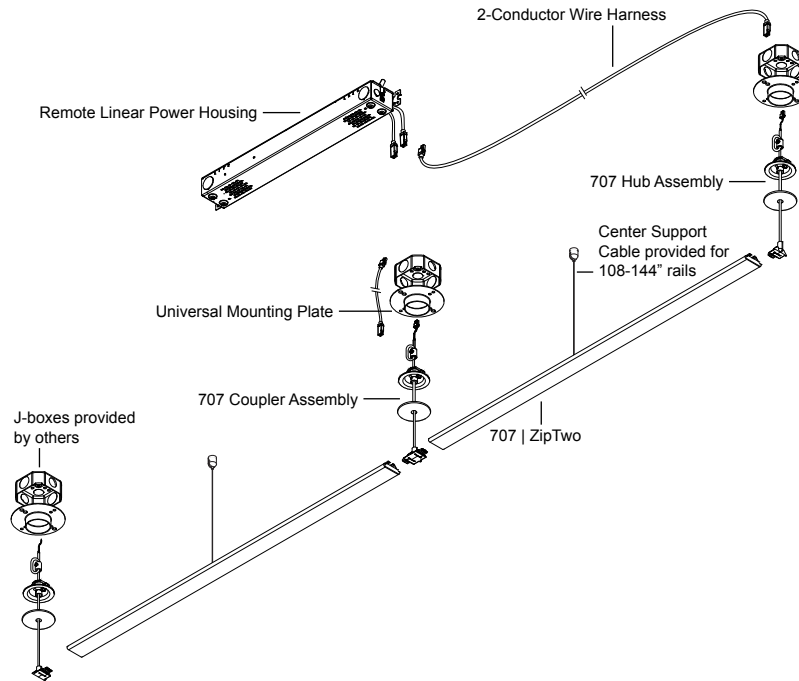

Finish

White Painted Finish



White Rail, White Canopy/Integral Power, White Cable

Black Anodized Finish



Black Rail, Black Canopy/Integral Power, Black Cable

Note: Drawings not to scale, for reference only.

Performance | Zipper LED

Zipper Board has 72 diodes per foot (305mm). Testing based on a 4' rail section. Lumen measurement complies with IES-LM-79-08 testing procedures.

Micro 3508, 40° Symmetric, white finish (S1-WH)

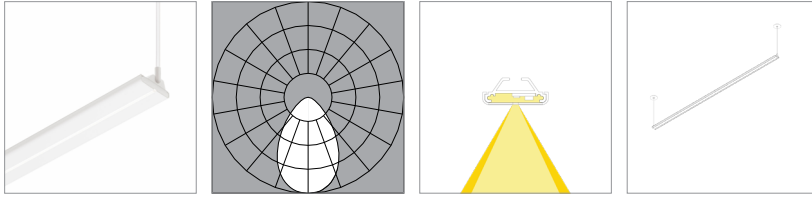

L80 >60,000 hours

	80 CRI (80min., 84 avg.)				90 CRI (90min., 96 avg.)			
	2700K	3000K	3500K	4000K	2700K	3000K	3500K	4000K
Low Output (LO)								
Efficacy - Lumens per Watt	57	58	60	60	49	50	51	52
Lumens per foot (305mm)	209	215	220	220	180	186	190	191
Watts per foot (305mm)	3.8	3.8	3.8	3.8	3.8	3.8	4	3.8

Standard Output (SO)								
Efficacy - Lumens per Watt	64	67	68	68	56	58	59	59
Lumens per foot (305mm)	418	431	440	440	360	371	379	383
Watts per foot (305mm)	6.6	6.6	6.6	6.6	6.6	6.6	6.6	6.6

High Output (HO)								
Efficacy - Lumens per Watt	64	66	67	67	55	57	58	59
Lumens per foot (305mm)	626	646	659	659	540	557	569	574
Watts per foot (305mm)	9.9	9.9	9.9	9.9	9.9	9.9	9.9	9.9

Micro 3508, 60° Symmetric, white finish (S2-WH)

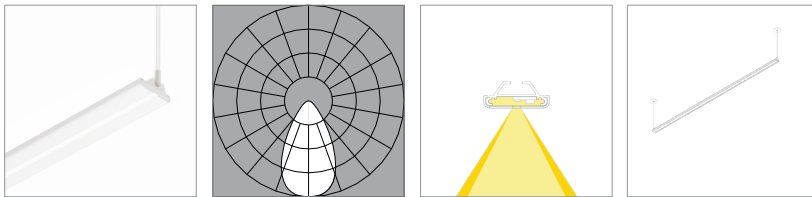

L80 >60,000 hours

	80 CRI (80min., 84 avg.)				90 CRI (90min., 96 avg.)			
	2700K	3000K	3500K	4000K	2700K	3000K	3500K	4000K
Low Output (LO)								
Efficacy - Lumens per Watt	88	91	92	92	76	78	80	81
Lumens per foot (305mm)	325	335	342	342	280	289	295	298
Watts per foot (305mm)	3.8	3.8	3.8	3.8	3.8	3.8	3.8	3.8

Standard Output (SO)								
Efficacy - Lumens per Watt	100	103	105	105	86	89	91	92
Lumens per foot (305mm)	650	671	684	684	561	578	590	596
Watts per foot (305mm)	6.6	6.6	6.6	6.6	6.6	6.6	6.6	6.6

High Output (HO)								
Efficacy - Lumens per Watt	99	102	104	104	86	88	90	91
Lumens per foot (305mm)	975	1006	1027	1027	841	867	885	894
Watts per foot (305mm)	9.9	9.9	9.9	9.9	9.9	9.9	9.9	9.9

Performance | Zipper LED Continued

Zipper Board has 72 diodes per foot (305mm). Testing based on a 4' rail section. Lumen measurement complies with IES-LM-79-08 testing procedures.

Micro 3508, 120° Symmetric, white finish (S3-WH)

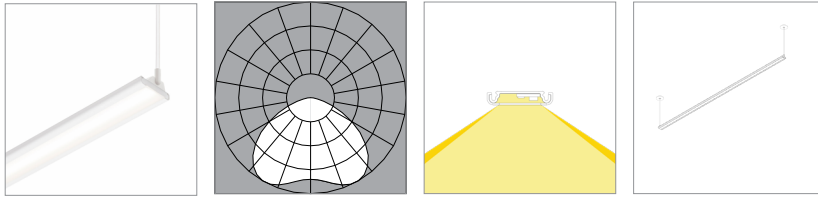

L80 >60,000 hours

	2700K	80 CRI (80min., 84 avg.)				2700K	90 CRI (90min., 96 avg.)		
		3000K	3500K	4000K	3000K		3500K	4000K	
Low Output (LO)									
Efficacy - Lumens per Watt	118	122	124	124	102	105	107	108	
Lumens per foot (305mm)	437	451	461	461	377	389	397	401	
Watts per foot (305mm)	3.8	3.8	3.8	3.8	3.8	3.8	3.8	3.8	

Standard Output (SO)

Efficacy - Lumens per Watt	133	138	140	140	116	120	122	124
Lumens per foot (305mm)	875	903	921	921	754	778	794	802
Watts per foot (305mm)	6.6	6.6	6.6	6.6	6.6	6.6	6.6	6.6

High Output (HO)

Efficacy - Lumens per Watt	133	137	140	140	115	119	121	122
Lumens per foot (305mm)	1312	1354	1382	1382	1131	1167	1191	1203
Watts per foot (305mm)	9.9	9.9	9.9	9.9	9.9	9.9	9.9	9.9

Micro 3508, 85° Asymmetric, white finish (A1-WH)

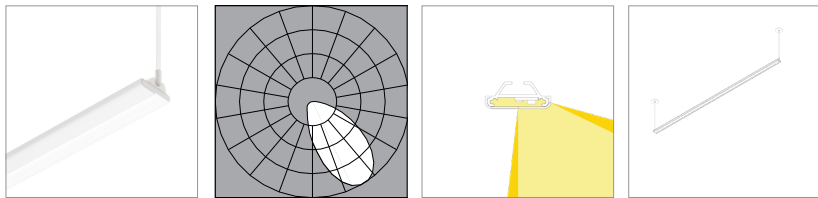

L80 >60,000 hours

	2700K	80 CRI (80min., 84 avg.)				2700K	90 CRI (90min., 96 avg.)		
		3000K	3500K	4000K	3000K		3500K	4000K	
Low Output (LO)									
Efficacy - Lumens per Watt	70	72	73	73	60	62	63	64	
Lumens per foot (305mm)	257	265	271	271	222	229	233	236	
Watts per foot (305mm)	3.8	3.8	3.8	3.8	3.8	3.8	3.8	3.8	

Standard Output (SO)

Efficacy - Lumens per Watt	79	82	83	83	69	71	72	73
Lumens per foot (305mm)	514	530	541	541	443	457	467	471
Watts per foot (305mm)	6.6	6.6	6.6	6.6	6.5	6.5	6.5	6.5

High Output (HO)

Efficacy - Lumens per Watt	78	81	83	83	68	70	71	72
Lumens per foot (305mm)	771	795	812	812	665	686	700	707
Watts per foot (305mm)	9.9	9.9	9.9	9.9	9.9	9.9	9.9	9.9

Performance | Zipper LED Continued

Zipper Board has 72 diodes per foot (305mm). Testing based on a 4' rail section. Lumen measurement complies with IES-LM-79-08 testing procedures.

Micro 3508, High Lumen, white finish (D3-WH)

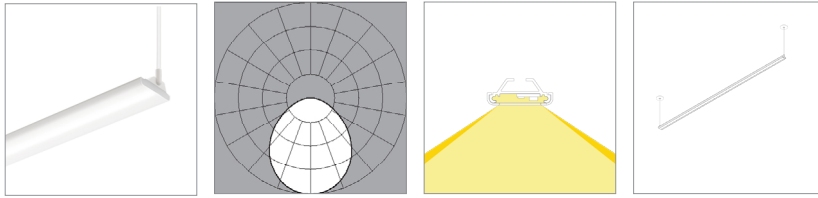

L80 >60,000 hours

	2700K	80 CRI (80min., 84 avg.)				2700K	90 CRI (90min., 96 avg.)		
		3000K	3500K	4000K	3000K		3500K	4000K	
Low Output (LO)									
Efficacy - Lumens per Watt	135	139	142	142	117	120	123	124	
Lumens per foot (305mm)	501	517	528	528	432	446	455	459	
Watts per foot (305mm)	3.8	3.8	3.8	3.8	3.8	3.8	3.8	3.8	

Standard Output (SO)

Efficacy - Lumens per Watt	154	159	162	162	133	137	140	141
Lumens per foot (305mm)	1003	1034	1055	1055	864	892	910	919
Watts per foot (305mm)	6.6	6.6	6.6	6.6	6.6	6.6	6.6	6.6

High Output (HO)

Efficacy - Lumens per Watt	153	157	161	161	132	136	139	140
Lumens per foot (305mm)	1504	1551	1583	1583	1296	1337	1365	1378
Watts per foot (305mm)	9.9	9.9	9.9	9.9	9.9	9.9	9.9	9.9

Micro 3508, High Lumen with MicroBaffle, white finish (D4-WH)

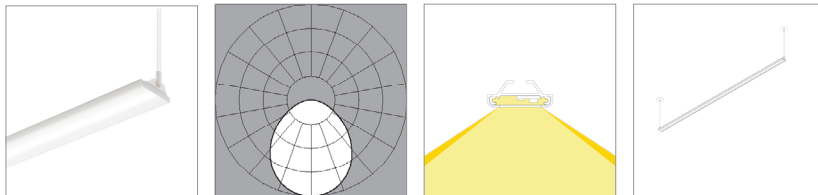

L80 >60,000 hours

	2700K	80 CRI (80min., 84 avg.)				2700K	90 CRI (90min., 96 avg.)		
		3000K	3500K	4000K	3000K		3500K	4000K	
Low Output (LO)									
Efficacy - Lumens per Watt	117	121	124	124	101	104	107	108	
Lumens per foot (305mm)	435	449	458	458	375	387	395	399	
Watts per foot (305mm)	3.8	3.8	3.8	3.8	3.8	3.8	3.8	3.8	

Standard Output (SO)

Efficacy - Lumens per Watt	134	138	141	141	116	119	122	123
Lumens per foot (305mm)	870	898	916	916	750	774	790	797
Watts per foot (305mm)	6.6	6.6	6.6	6.6	6.6	6.6	6.6	6.6

High Output (HO)

Efficacy - Lumens per Watt	132	137	139	139	114	118	120	121
Lumens per foot (305mm)	1305	1346	1374	1374	1125	1161	1184	1196
Watts per foot (305mm)	9.9	9.9	9.9	9.9	9.9	9.9	9.9	9.9

Performance | Zipper LED Continued

Zipper Board has 72 diodes per foot (305mm). Testing based on a 4' rail section. Lumen measurement complies with IES-LM-79-08 testing procedures.

Micro 3508, 40° Symmetric, black finish (S1-BL)

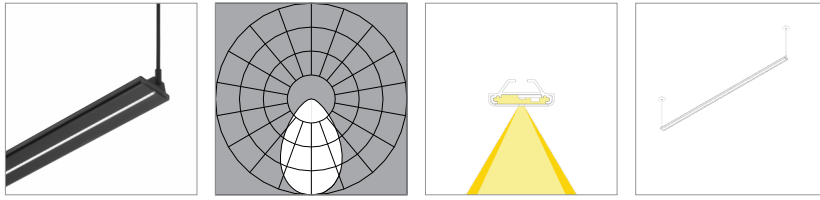

L80 >60,000 hours

	80 CRI (80min., 84 avg.)				90 CRI (90min., 96 avg.)			
	2700K	3000K	3500K	4000K	2700K	3000K	3500K	4000K
Low Output (LO)								
Efficacy - Lumens per Watt	42	44	44	44	36	38	38	39
Lumens per foot (305mm)	155	160	163	163	134	138	141	142
Watts per foot (305mm)	3.8	3.8	3.8	3.8	3.8	3.8	3.8	3.8

Standard Output (SO)								
Efficacy - Lumens per Watt	48	50	51	51	42	43	44	44
Lumens per foot (305mm)	310	320	327	327	268	276	282	285
Watts per foot (305mm)	6.6	6.6	6.6	6.6	6.6	6.6	6.6	6.6
CRI								

High Output (HO)								
Efficacy - Lumens per Watt	48	49	50	50	41	42	43	44
Lumens per foot (305mm)	466	480	490	490	401	414	423	427
Watts per foot (305mm)	9.9	9.9	9.9	9.9	9.9	9.9	9.9	9.9
CRI								

Micro 3508, 60° Symmetric, black finish (S2-BL)

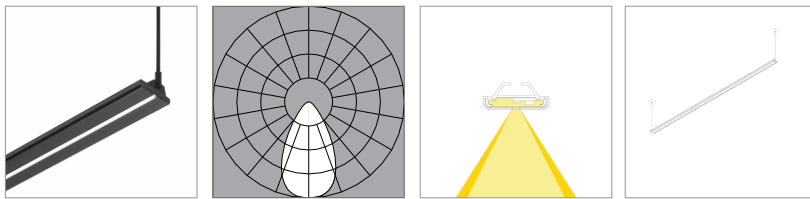

L80 >60,000 hours

	80 CRI (80min., 84 avg.)				90 CRI (90min., 96 avg.)			
	2700K	3000K	3500K	4000K	2700K	3000K	3500K	4000K
Low Output (LO)								
Efficacy - Lumens per Watt	70	73	74	74	61	63	64	65
Lumens per foot (305mm)	260	269	274	274	224	232	236	239
Watts per foot (305mm)	3.8	3.8	3.8	3.8	3.8	3.8	3.8	3.8

Standard Output (SO)								
Efficacy - Lumens per Watt	80	83	84	84	69	72	73	74
Lumens per foot (305mm)	521	537	548	548	449	463	473	477
Watts per foot (305mm)	6.6	6.6	6.6	6.6	6.6	6.6	6.6	6.6

High Output (HO)								
Efficacy - Lumens per Watt	79	82	84	84	69	71	72	73
Lumens per foot (305mm)	781	806	822	822	673	695	709	716
Watts per foot (305mm)	9.9	9.9	9.9	9.9	9.9	9.9	9.9	9.9

Performance | Zipper LED Continued

Zipper Board has 72 diodes per foot (305mm). Testing based on a 4' rail section. Lumen measurement complies with IES-LM-79-08 testing procedures.

Micro 3508, 120° Symmetric, black finish (S3-BL)

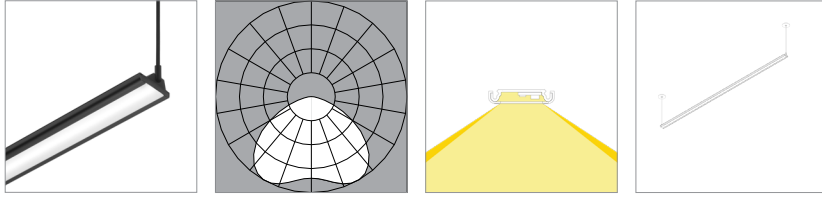

L80 >60,000 hours

	80 CRI (80min., 84 avg.)				90 CRI (90min., 96 avg.)			
	2700K	3000K	3500K	4000K	2700K	3000K	3500K	4000K
Low Output (LO)								
Efficacy - Lumens per Watt	102	105	107	107	88	90	92	93
Lumens per foot (305mm)	376	388	396	396	325	335	342	345
Watts per foot (305mm)	3.8	3.8	3.8	3.8	3.8	3.8	3.8	3.8

Standard Output (SO)								
Efficacy - Lumens per Watt	116	119	122	122	100	103	105	106
Lumens per foot (305mm)	753	777	793	793	649	670	683	690
Watts per foot (305mm)	6.6	6.6	6.6	6.6	6.6	6.6	6.6	6.6

High Output (HO)								
Efficacy - Lumens per Watt	115	118	121	121	99	102	104	105
Lumens per foot (305mm)	1129	1165	1189	1189	974	1004	1025	1035
Watts per foot (305mm)	9.9	9.9	9.9	9.9	9.9	9.9	9.9	9.9

Micro 3508, 85° Asymmetric, black finish (A1-BL)

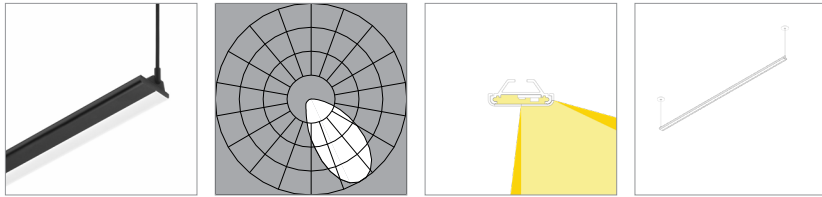

L80 >60,000 hours

	80 CRI (80min., 84 avg.)				90 CRI (90min., 96 avg.)			
	2700K	3000K	3500K	4000K	2700K	3000K	3500K	4000K
Low Output (LO)								
Efficacy - Lumens per Watt	38	39	39	39	32	33	34	34
Lumens per foot (305mm)	138	142	145	145	119	123	125	126
Watts per foot (305mm)	3.8	3.8	3.8	3.8	3.8	3.8	3.8	3.8

Standard Output (SO)								
Efficacy - Lumens per Watt	43	44	45	45	37	38	39	39
Lumens per foot (305mm)	276	284	290	290	238	245	250	253
Watts per foot (305mm)	6.6	6.6	6.6	6.6	6.5	6.5	6.5	6.5

High Output (HO)								
Efficacy - Lumens per Watt	42	44	44	44	37	38	38	39
Lumens per foot (305mm)	413	426	435	435	356	368	375	379
Watts per foot (305mm)	9.9	9.9	9.9	9.9	9.9	9.9	9.9	9.9

© 2021 Vode Lighting LLC. All rights reserved.

The Vode logo and Vode, ZipTwo, MicroBaffle and Zipper Board names are either registered trademarks or trademarks of Vode Lighting LLC in the United States and/or other countries. All other brand or product names are trademarks or registered trademarks of their respective owners. Due to ongoing innovation, specifications may change without notice.