

Spec Guide

# DoubleBox™ | Ceiling Cable | 107

Direct/indirect lighting for ambient, open office, conference room and wall wash applications.



DoubleBox, direct/indirect

### Benefits & Features

#### Minimal Profile, Robust Design

Rectangular profile, 2.48" (63mm) x 1.14" (29mm).

#### Superior Light Quality & Performance

Output up to 2972 lm/ft (9752 lm/m) (HO), 131 Lm/W (SO), 80/90 CRI & 2200K-5000K Tunable White available.

#### Adaptive Power

Full range dimming power for all protocols. Integral or remote power available.

#### Better Optics & Beam Control

Options of Batwing, FlyWing, black or white baffle, diffuse lens and narrow optics for ambient, grazing or wall wash. Excellent glare control using optical film and patented MicroBaffle.

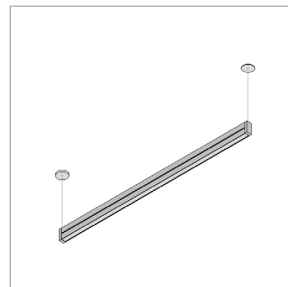

Small Round Canopy

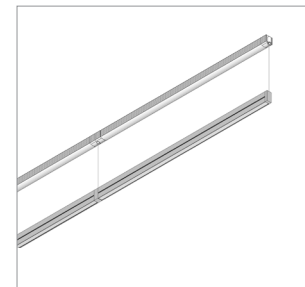

Integral Power, Continuous System

## Build Your Specification

<b>107-DB</b>	<b>01</b>			<b>CC</b>	▶▶
---------------	-----------	--	--	-----------	----

System & Rail Type	Single/Double Rail	System Length	Rail Length	Mounting	Cable Length <i>Field adjustable.</i>
<b>107-DB</b> DoubleBox	<b>01</b> Single Rail	Specify overall system length in ft/in or M/mm.  <i>Corner and Shapes Available</i> <a href="#">See Guide</a> for details	<b>24</b> 24" (610mm) <b>36</b> 36" (914mm) <b>48</b> 48" (1219mm) <b>60</b> 60" (1524mm) <b>72</b> 72" (1820mm) <b>96</b> 96" (2438mm) <b>ZZ</b> Other rail length or layout (please specify)  <i>See <a href="#">Rail Length Chart</a> for more details</i>	<b>CC</b> Ceiling Cable	<b>48</b> 48" cable (1210mm) <b>96</b> 96" cable (2438mm) <b>ZZ</b> Other (please specify)

				<b>0</b>	▶▶
--	--	--	--	----------	----

Power Location	Power Type*	Voltage	Emergency Power
<b>Integral Power</b>	<b>Flexible 1 to 1 Power</b>	<b>1</b> 120v <b>2</b> 120v-277v <b>X</b> Not Yet Specified	<b>0</b> No Emergency Power <b>ZZ</b> Emergency Power Required ( <i>specify requirements</i> )
<b>IP</b> Integral Power	<b>AE</b> eldoLED 0-10v, 1.0% Dimming		
<b>Remote Power</b>	<b>AT</b> eldoLED 0-10v, 0.1% Dimming		
<b>Small Round Canopy</b>	<b>AD</b> eldoLED DALI, 0.1% Dimming		
<b>2R25</b> 25' (7.62m) Wire Harness	<b>AX</b> eldoLED DMX, 100-0% Dimming		
<b>2R50</b> 50' (15.24m) Wire Harness	<b>AH</b> Hi-lume 1% EcoSystem, Soft On / Fade to Black Technology, LDE1		
<b>2R75</b> 75' (22.86m) Wire Harness	<b>AH2</b> Hi-lume 1% 2-wire LTEA2W (120V forward phase only)		
<b>2R100</b> 100' (30.48m) Wire Harness	<b>Optimized Power</b>		
<b>Large Round Canopy</b>	<b>AEO</b> eldoLED 0-10v, 1.0% Dimming		
<b>4R25</b> 25' (7.62m) Wire Harness	<b>ATO</b> eldoLED 0-10v, 0.1% Dimming		
<b>4R50</b> 50' (15.24m) Wire Harness	<b>ADO</b> eldoLED DALI, 0.1% Dimming		
<b>4R75</b> 75' (22.86m) Wire Harness	<b>AXO</b> eldoLED DMX, 100-0% dimming		
<b>4R100</b> 100' (30.48m) Wire Harness	<b>ZZ</b> Other (please specify)		

\*See [Power Guide](#) for driver features & limitations.

<b>Z</b>				
----------	--	--	--	--

LED Type	Lumen Output*	Color Temperature	Optics	Sensors
<b>Z</b> Zipper Board™	<b>LO</b> Low Output <b>SO</b> Standard Output <b>HO</b> High Output <b>ZZ</b> Other (please specify)  <i>See <a href="#">IES Files</a> page for details.</i> <i>*See <a href="#">Power Guide</a> for driver features &amp; limitations.</i>	<b>80+ CRI</b> <b>27</b> 2700K <b>30</b> 3000K <b>35</b> 3500K <b>40</b> 4000K  <b>90+ CRI</b> <b>279</b> 2700K <b>309</b> 3000K <b>359</b> 3500K <b>409</b> 4000K  <b>ZZ</b> Tunable White Available <a href="#">See Guide</a> for details	<b>Zipper Board™ (Z)</b> <b>G12</b> 120° Batwing, up   Diffuse, down <b>G1WB</b> 120° Batwing, up   White Baffle, down <b>G1BB</b> 120° Batwing, up   Black Baffle, down <b>G1S1</b> 120° Batwing, up   40° Symmetric, down <b>G1S2</b> 120° Batwing, up   60° Symmetric, down <b>G1A1</b> 120° Batwing, up   85° Asymmetric, down <b>G1G2</b> 120° Batwing, up   120° FlyWing, down	<b>0</b> None <b>ZZ</b> Sensor ( <i>specify requirements</i> )

▶▶	
----	--

Finish	Options
<b>AL</b> Clear Anodized	<b>0</b> None
<b>WH</b> White Painted	<b>9</b> 9' 18/3 Cord and Plug <sup>2</sup>
<b>BL</b> Black Anodized	
<b>ZZ</b> Other (please specify)	

### NOTES & LIMITATIONS

<sup>1</sup>Integral Power (IP) is not available with 24" rail lengths in AE, AH, AH2  
<sup>2</sup>9' 18/3 Cord and Plug only available with Remote Power (RP)

5 Year Limited Warranty. See full Vode warranty description [here](#) or at [vode.com](#).

Listed to UL standards for damp location by a Nationally Recognized Testing Laboratory (NRTL) recognized by OSHA.



## Applications

### General Interior, Open Office, and Conference Room

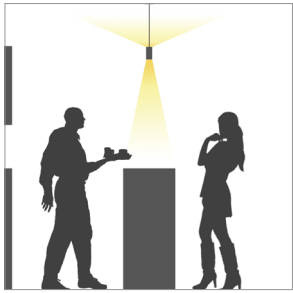

Square Inc, San Francisco, CA



PCH Innovation, San Francisco, CA

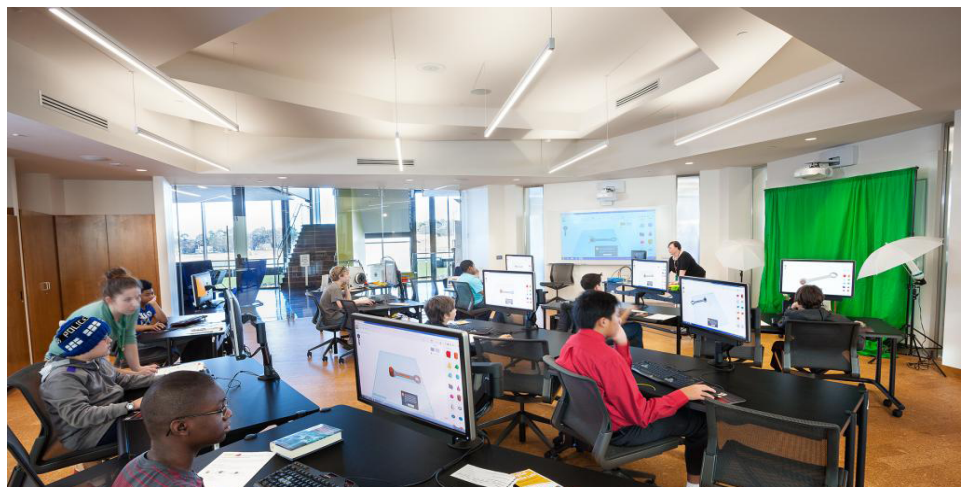
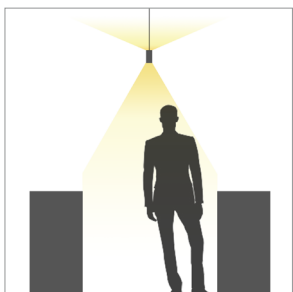

Libbie Mill Library, Richmond, VA



## Applications

### General Interior, Open Office, and Conference Room



Harold C. Smith Learning Commons, Springfield, MA



## Structure

Rail Length	24" (610mm), 36" (914mm), 48" (1219mm), 60" (1524mm), 72" (1829mm), 96" (2438mm)
Rail Dimension	2.48" x 1.14" (63mm x 29mm)
Construction / Finish	Extruded and machined 6063 aluminum. Clear anodized, black anodized, white painted and non-standard finishes available.
Mounting	Ceiling mount to jbox or integral power driver housing.
Cable Length	48" (1219mm) and 96" (2438mm) available. Field adjustable. Non-standard cable lengths available.
System Run Length	24" (610mm) minimum. Unlimited maximum length.
Operating Temperature	32°F to 104°F (0°C to 40°C).
Humidity	0-85%, non-condensing
System Weight	1.22lbs per ft (0.56kg per 305mm) <i>Remote Power supply and mounting hardware not included.</i>

## Materials

LED Board Construction	Aluminum core PCB, black LCP connectors, RoHS compliant
Lens	High-impact extruded acrylic glass (PMMA)
Baffle	6063 aluminum, RoHS compliant painted finish
Suspension Cable	Ø3.8mm, 22/2 AWG, PVC or TPE and RoHS compliant ( <i>PVC free in 2020</i> )
Power Cable	Ø4mm, 18/2 AWG, Plenum (CMP) rated semi-rigid PVC or FEP, flame tested UL-910 ( <i>PVC free in 2020</i> )
Cable Connectors	Unfilled black nylon, rated UL 94 V-0, halogen free, PVC or FEP overmold, RoHS compliant ( <i>PVC free in 2020</i> )
Remote Linear Power Housing (RLP)	20.7" x 2.375" x 2.53", 0.054" formed Galvanized Steel
Remote Brick Power Housing (RBP)	4.32" x 3.37" x .078" Galvanized Steel mounting plate

## Dimensions

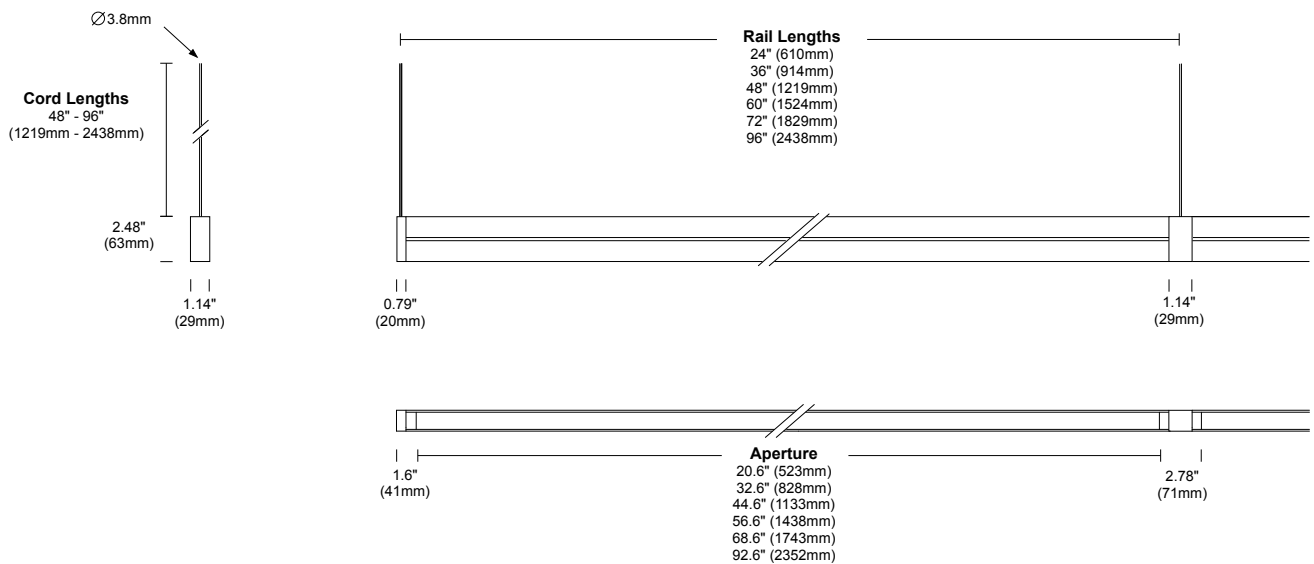

## Mounting Options

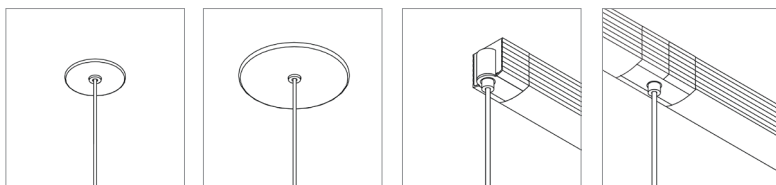

Small Round Canopy  
Ø2.5" (51mm)

Large Round Canopy  
Ø4.5" (114mm)

Integral Power (end)  
h 1.7" (43mm)  
w 1.8" (46mm)

Integral Power (joint)

## Layout

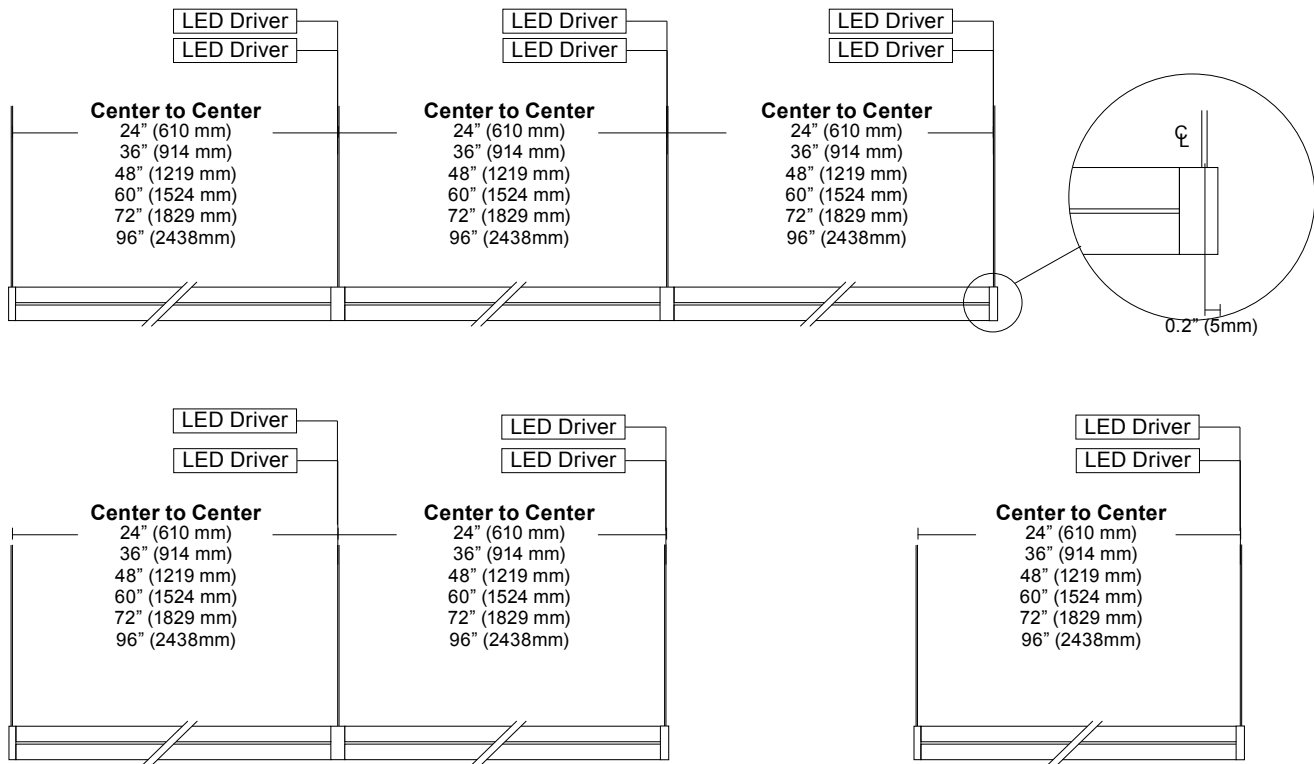

Corner and Shapes Available (Square, Rectangle, L-Shape, U-Shape, ZigZag)

## Power and Controls

Power Type	Class 2 (<60v output) constant current driver
Dimming Controls	Dimming (0.1%, 1%), 0-10v, DALI, DMX, Lutron Hi-lume 1% are available. See <a href="#">Power Guide</a> for details.
Input Voltage	120v - 277v, 50/60hz
Power Location	Integral or remote power. Maximum remote distance up to 100' (30.5m) depending on driver selection. See <a href="#">Power Guide</a> for details.

Vode power locations fall into two categories: integral and remote. Remote power is locating the power supply away from the fixture. Remote power comes in two housing styles: brick style and linear style. Consult [Power Guide](#) to determine which type you will receive. Integral power is locating the power supply into the lighting fixture or mounting.

### Remote Brick Power Housing

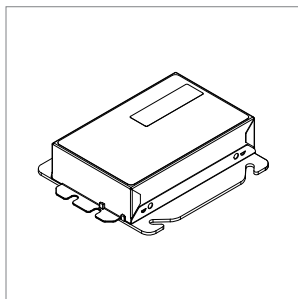

Supplied for some remote power applications. One remote power supply housing is supplied for each rail. Provided driver mounting plate fits standard 4" metal, square J-Boxes with a minimum volume of 21 in<sup>3</sup> (J-Box not provided). See [Tech Sheet](#) for details.

### Remote Linear Power Housing

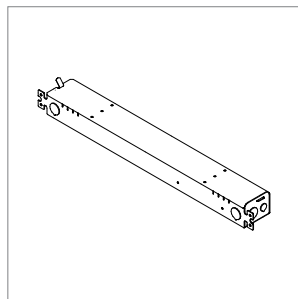

One remote power supply housing is supplied with each power supply. All Vode linear remote drivers come in a 0.054" (0.8mm) formed galvanized steel power supply housing with five (5) knockouts: (4) 1-1/8", (1) 7/8" and (1) 9/16". Accommodates standard linear power supplies. See [Tech Sheet](#) for details.

### Integral Power

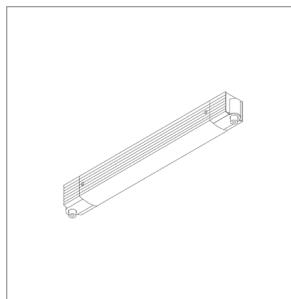

Houses integral power supply. Direct conduit feed is recommended, but integral power supply housing will mount to any standard North America 4" j-box. Mounts to most surfaces. Blocking is recommended at all arm junctions. See [Tech Sheet](#) for details.

### Wire Harness

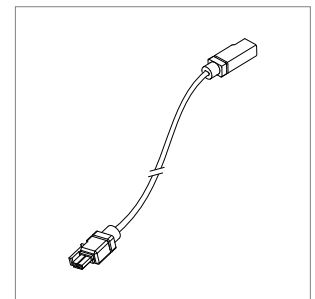

Wire harness connects driver to rail. Wire harness is 25' (7.6m) with micro fit molex connectors for quick and easy installation. Multiple harnesses can be combined for a total length of up to 100' (30.5m). See [Tech Sheet](#) for details.



## Power and Controls

### Flexible 1 to 1 power

For Flexible 1 to 1 Power, Vode supplies one single output driver per fixture, allowing each fixture to be controlled independently. Direct/Indirect fixtures are supplied with two single output drivers, allowing the direct and indirect lighting to be controlled independently. Consult [Power Guide](#) to determine which type you will receive.

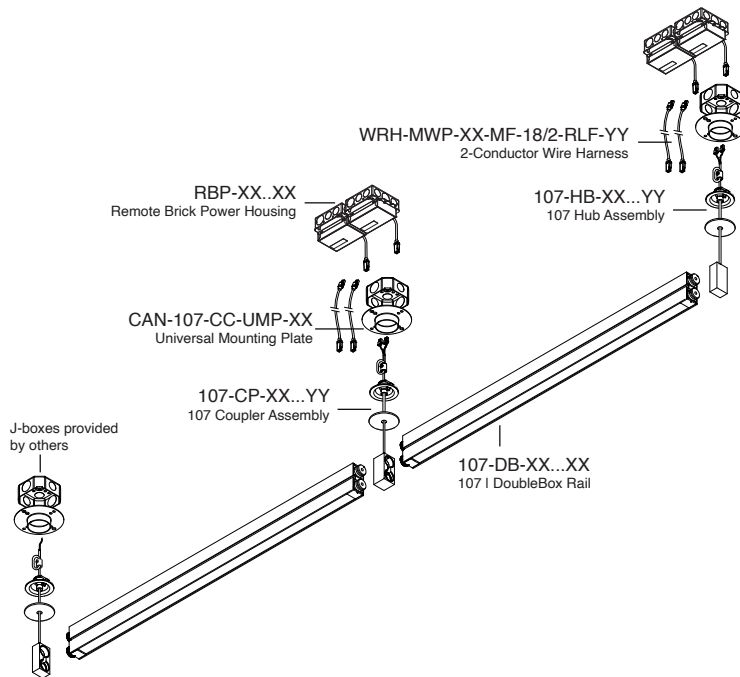

### Optimized Power

To optimize power, Vode configures specifications with drivers that have 2 or 4 outputs. Depending on system configurations and power requirements, up to 4 fixtures can be powered from a 4-output driver. Consult [Power Guide](#) to determine which type you will receive.

IMPORTANT: Each fixture will still require individual wire harnesses, as shown below.

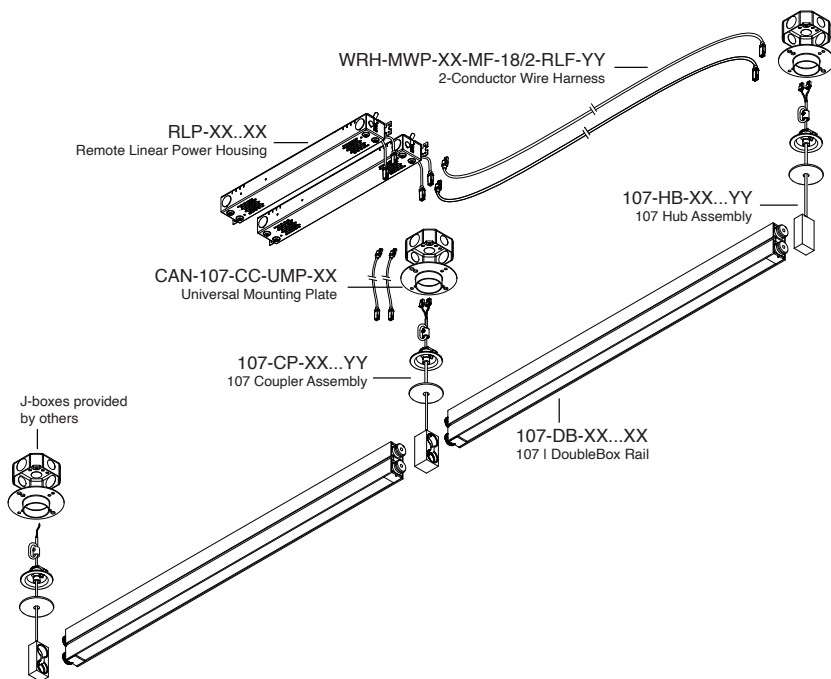

Note: Drawings not to scale, for reference only.

## Power and Controls

### Wire Harness

Low voltage wire harness connects driver to rail. Wire harness is 25' (7.6m) 18/2 AWG stranded wire with provided micro fit molex connectors on either end for quick and easy installation. Multiple harnesses can be combined for a total length of up to 100' (30.5m). Refer to Vode Power Guide for max remote distance based on power selection. Consult [Power Guide](#) to determine which type you will receive.

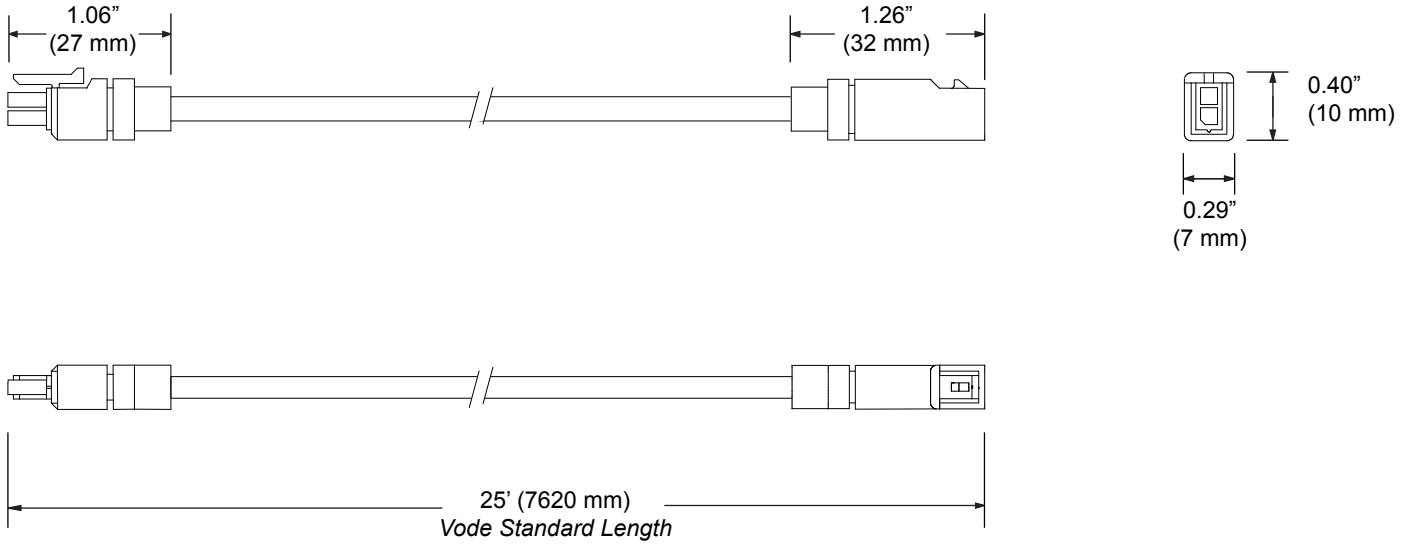

Note: Drawings not to scale, for reference only.



## Finish

Clear Anodized Finish



Clear Anodized Rail, White Canopy/Integral Power, Clear Anodized Integral Power, Clear Cable

Black Anodized Finish



Black Rail, Black Canopy/Integral Power, Black Cable

White Painted Finish



White Rail, White Canopy/Integral Power, White Cable

## Performance | Zipper LED Continued

Zipper Board has 72 diodes per foot (305mm). Testing based on a 4' rail section. Lumen measurement complies with IES-LM-79-08 testing procedures.

120° Batwing, up | Diffuse, down (G12)

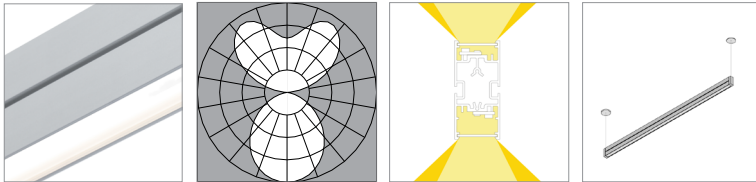

L80 >60,000 hours

### 80 CRI (80min., 84 avg.)

#### Low Output (LO)

	2700K	3000K	3500K	4000K	2700K	3000K	3500K	4000K
Efficacy - Lumens per Watt	101	104	106	106	87	90	92	93
Lumens per foot (305mm)	693	715	730	730	598	617	629	635
Watts per foot (305mm)	6.9	6.9	6.9	6.9	6.9	6.9	6.9	6.9

#### Standard Output (SO)

Efficacy - Lumens per Watt	116	120	123	123	101	104	106	107
Lumens per foot (305mm)	1387	1430	1460	1460	1195	1233	1258	1271
Watts per foot (305mm)	12.0	12.0	12.0	12.0	12.0	12.0	12.0	12.0

#### High Output (HO)

Efficacy - Lumens per Watt	108	111	114	114	93	96	98	99
Lumens per foot (305mm)	2635	2718	2773	2773	2271	2343	2391	2415
Watts per foot (305mm)	24.6	24.6	24.6	24.6	24.6	24.6	24.6	24.6

## Performance | Zipper LED Continued

Zipper Board has 72 diodes per foot (305mm). Testing based on a 4' rail section. Lumen measurement complies with IES-LM-79-08 testing procedures.

### 120° Batwing, up | 120° Flywing, down (G1G2)

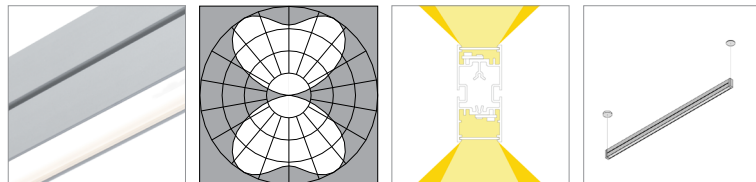

L80 >60,000 hours

	80 CRI (80min., 84 avg.)				90 CRI (90min., 96 avg.)			
	2700K	3000K	3500K	4000K	2700K	3000K	3500K	4000K
<b>Low Output (LO)</b>								
Efficacy - Lumens per Watt	110	113	115	115	95	97	99	100
Lumens per foot (305mm)	752	776	792	792	649	669	683	690
Watts per foot (305mm)	6.9	6.9	6.9	6.9	6.9	6.9	6.9	6.9
<b>Standard Output (SO)</b>								
Efficacy - Lumens per Watt	126	130	133	133	109	112	115	116
Lumens per foot (305mm)	1505	1552	1584	1584	1297	1338	1366	1379
Watts per foot (305mm)	12.0	12.0	12.0	12.0	12.0	12.0	12.0	12.0
<b>High Output (HO)</b>								
Efficacy - Lumens per Watt	117	121	123	123	101	104	106	107
Lumens per foot (305mm)	2859	2949	3010	3010	2465	2543	2594	2620
Watts per foot (305mm)	24.6	24.6	24.6	24.6	24.6	24.6	24.6	24.6

### 120° Batwing, up | White Baffle, down (G1WB)

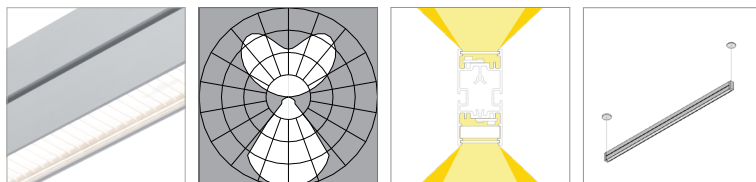

L80 >60,000 hours

	80 CRI (80min., 84 avg.)				90 CRI (90min., 96 avg.)			
	2700K	3000K	3500K	4000K	2700K	3000K	3500K	4000K
<b>Low Output (LO)</b>								
Efficacy - Lumens per Watt	87	90	91	91	75	77	79	80
Lumens per foot (305mm)	595	614	627	627	513	529	540	546
Watts per foot (305mm)	6.9	6.9	6.9	6.9	6.9	6.9	6.9	6.9
<b>Standard Output (SO)</b>								
Efficacy - Lumens per Watt	100	103	105	105	86	89	91	92
Lumens per foot (305mm)	1191	1228	1253	1253	1026	1059	1081	1091
Watts per foot (305mm)	12.0	12.0	12.0	12.0	12.0	12.0	12.0	12.0
<b>High Output (HO)</b>								
Efficacy - Lumens per Watt	93	96	98	98	80	83	84	85
Lumens per foot (305mm)	2262	2334	2381	2381	1950	2012	2053	2073
Watts per foot (305mm)	24.6	24.6	24.6	24.6	24.6	24.6	24.6	24.6



## Performance | Zipper LED Continued

Zipper Board has 72 diodes per foot (305mm). Testing based on a 4' rail section. Lumen measurement complies with IES-LM-79-08 testing procedures.

### 120° Batwing, up | Black Baffle, down (G1BB)

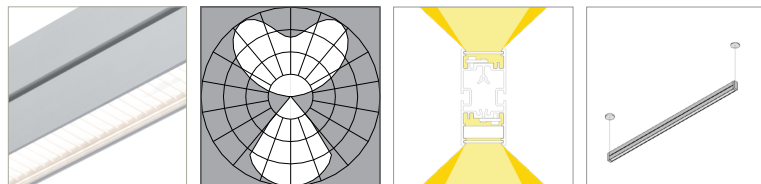

L80 >60,000 hours

	80 CRI (80min., 84 avg.)				90 CRI (90min., 96 avg.)			
	2700K	3000K	3500K	4000K	2700K	3000K	3500K	4000K
<b>Low Output (LO)</b>								
Efficacy - Lumens per Watt	72	74	76	76	62	64	65	66
Lumens per foot (305mm)	492	508	518	518	424	438	447	451
Watts per foot (305mm)	6.9	6.9	6.9	6.9	6.9	6.9	6.9	6.9

### Standard Output (SO)

Efficacy - Lumens per Watt	83	85	87	87	72	74	75	76
Lumens per foot (305mm)	985	1016	1036	1036	849	876	894	902
Watts per foot (305mm)	12.0	12.0	12.0	12.0	12.0	12.0	12.0	12.0

### High Output (HO)

Efficacy - Lumens per Watt	77	79	81	81	66	68	70	70
Lumens per foot (305mm)	1871	1930	1969	1969	1613	1664	1698	1715
Watts per foot (305mm)	24.6	24.6	24.6	24.6	24.6	24.6	24.6	24.6

### 120° Batwing, up | 40° Symmetric, down (G1S1)

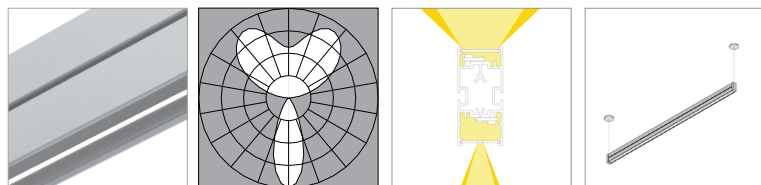

L80 >60,000 hours

	80 CRI (80min., 84 avg.)				90 CRI (90min., 96 avg.)			
	2700K	3000K	3500K	4000K	2700K	3000K	3500K	4000K
<b>Low Output (LO)</b>								
Efficacy - Lumens per Watt	77	80	81	81	67	69	70	71
Lumens per foot (305mm)	530	547	558	558	457	471	481	486
Watts per foot (305mm)	6.9	6.9	6.9	6.9	6.9	6.9	6.9	6.9

### Standard Output (SO)

Efficacy - Lumens per Watt	89	92	94	94	77	79	81	82
Lumens per foot (305mm)	1060	1093	1116	1116	914	943	962	971
Watts per foot (305mm)	12.0	12.0	12.0	12.0	12.0	12.0	12.0	12.0

### High Output (HO)

Efficacy - Lumens per Watt	83	85	87	87	71	74	75	76
Lumens per foot (305mm)	2014	2077	2120	2120	1736	1791	1827	1846
Watts per foot (305mm)	24.6	24.6	24.6	24.6	24.6	24.6	24.6	24.6

## Performance | Zipper LED Continued

Zipper Board has 72 diodes per foot (305mm). Testing based on a 4' rail section. Lumen measurement complies with IES-LM-79-08 testing procedures.

### 120° Batwing, up | 60° Symmetric, down (G1S2)

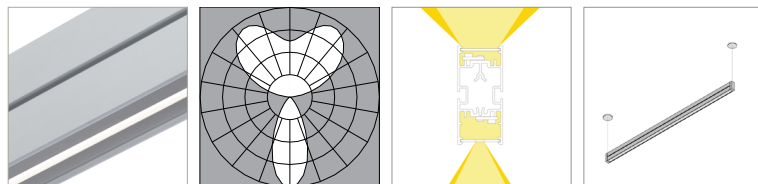

L80 >60,000 hours

	80 CRI (80min., 84 avg.)				90 CRI (90min., 96 avg.)			
	2700K	3000K	3500K	4000K	2700K	3000K	3500K	4000K
<b>Low Output (LO)</b>								
Efficacy - Lumens per Watt	85	88	90	90	74	76	77	78
Lumens per foot (305mm)	585	603	616	616	504	520	531	536
Watts per foot (305mm)	6.9	6.9	6.9	6.9	6.9	6.9	6.9	6.9
<b>Standard Output (SO)</b>								
Efficacy - Lumens per Watt	98	101	103	103	85	88	89	90
Lumens per foot (305mm)	1170	1207	1231	1231	1008	1040	1062	1072
Watts per foot (305mm)	12.0	12.0	12.0	12.0	12.0	12.0	12.0	12.0
<b>High Output (HO)</b>								
Efficacy - Lumens per Watt	91	94	96	96	79	81	83	84
Lumens per foot (305mm)	2223	2293	2340	2340	1916	1977	2017	2037
Watts per foot (305mm)	24.6	24.6	24.6	24.6	24.6	24.6	24.6	24.6

### 120° Batwing, up | 85° Asymmetric, down (G1A1)

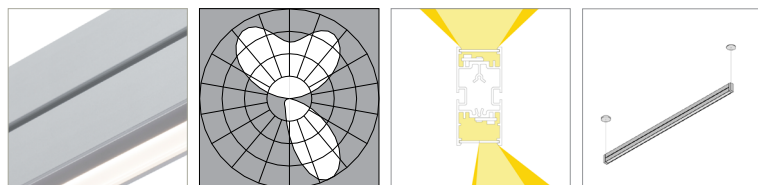

L80 >60,000 hours

	80 CRI (80min., 84 avg.)				90 CRI (90min., 96 avg.)			
	2700K	3000K	3500K	4000K	2700K	3000K	3500K	4000K
<b>Low Output (LO)</b>								
Efficacy - Lumens per Watt	86	89	90	90	74	76	78	79
Lumens per foot (305mm)	590	608	621	621	508	524	535	540
Watts per foot (305mm)	6.9	6.9	6.9	6.9	6.9	6.9	6.9	6.9
<b>Standard Output (SO)</b>								
Efficacy - Lumens per Watt	99	102	104	104	86	88	90	91
Lumens per foot (305mm)	1179	1216	1241	1241	1017	1049	1070	1081
Watts per foot (305mm)	12.0	12.0	12.0	12.0	12.0	12.0	12.0	12.0
<b>High Output (HO)</b>								
Efficacy - Lumens per Watt	92	95	97	97	79	82	83	84
Lumens per foot (305mm)	2240	2311	2358	2358	1931	1992	2033	2053
Watts per foot (305mm)	24.6	24.6	24.6	24.6	24.6	24.6	24.6	24.6



## Performance | Zipper LED Continued

Zipper Board has 72 diodes per foot (305mm). Testing based on a 4' rail section. Lumen measurement complies with IES-LM-79-08 testing procedures.

### 120° Batwing, up | 40° Symmetric, down, black finish (G1S1-BL)

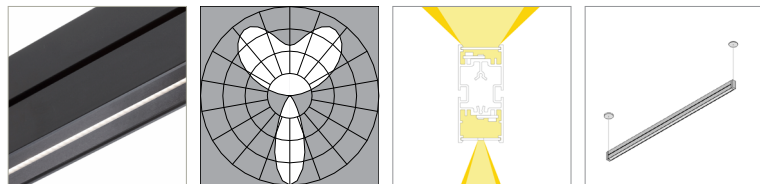

L80 >60,000 hours

	80 CRI (80min., 84 avg.)				90 CRI (90min., 96 avg.)			
	2700K	3000K	3500K	4000K	2700K	3000K	3500K	4000K
<b>Low Output (LO)</b>								
Efficacy - Lumens per Watt	71	73	75	75	61	63	65	65
Lumens per foot (305mm)	487	502	512	512	420	433	442	446
Watts per foot (305mm)	6.9	6.9	6.9	6.9	6.9	6.9	6.9	6.9

<b>Standard Output (SO)</b>								
Efficacy - Lumens per Watt	82	84	86	86	71	73	74	75
Lumens per foot (305mm)	973	1004	1025	1025	839	866	883	892
Watts per foot (305mm)	12.0	12.0	12.0	12.0	12.0	12.0	12.0	12.0

<b>High Output (HO)</b>								
Efficacy - Lumens per Watt	76	78	80	80	66	68	69	70
Lumens per foot (305mm)	1849	1908	1947	1947	1594	1645	1678	1695
Watts per foot (305mm)	24.6	24.6	24.6	24.6	24.6	24.6	24.6	24.6

### 120° Batwing, up | 60° Symmetric, down, black finish (G1S2-BL)

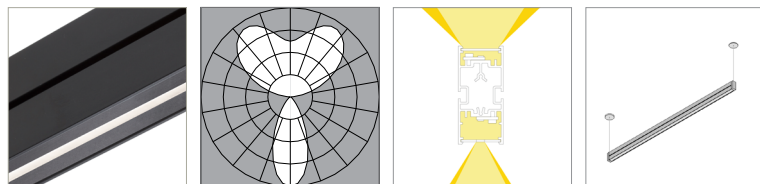

L80 >60,000 hours

	80 CRI (80min., 84 avg.)				90 CRI (90min., 96 avg.)			
	2700K	3000K	3500K	4000K	2700K	3000K	3500K	4000K
<b>Low Output (LO)</b>								
Efficacy - Lumens per Watt	74	76	78	78	64	66	67	68
Lumens per foot (305mm)	505	521	532	532	436	449	459	463
Watts per foot (305mm)	6.9	6.9	6.9	6.9	6.9	6.9	6.9	6.9

<b>Standard Output (SO)</b>								
Efficacy - Lumens per Watt	85	88	89	89	73	76	77	78
Lumens per foot (305mm)	1011	1042	1064	1064	871	899	917	926
Watts per foot (305mm)	12.0	12.0	12.0	12.0	12.0	12.0	12.0	12.0

<b>High Output (HO)</b>								
Efficacy - Lumens per Watt	79	81	83	83	68	70	72	72
Lumens per foot (305mm)	1920	1981	2021	2021	1655	1707	1742	1760
Watts per foot (305mm)	24.6	24.6	24.6	24.6	24.6	24.6	24.6	24.6

## Performance | Zipper LED Continued

Zipper Board has 72 diodes per foot (305mm). Testing based on a 4' rail section. Lumen measurement complies with IES-LM-79-08 testing procedures.

120° Batwing, up | 85° Asymmetric, down, black finish (G1A1-BL)

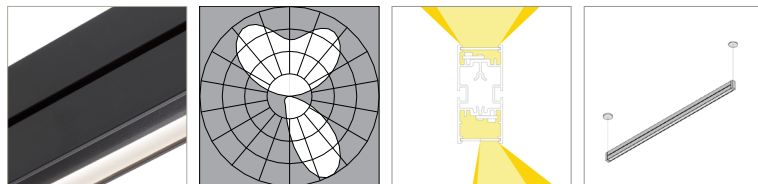

L80 >60,000 hours

	80 CRI (80min., 84 avg.)				90 CRI (90min., 96 avg.)			
	2700K	3000K	3500K	4000K	2700K	3000K	3500K	4000K
<b>Low Output (LO)</b>								
Efficacy - Lumens per Watt	80	83	84	84	69	71	73	73
Lumens per foot (305mm)	549	566	577	577	473	488	498	503
Watts per foot (305mm)	6.9	6.9	6.9	6.9	6.9	6.9	6.9	6.9
<b>Standard Output (SO)</b>								
Efficacy - Lumens per Watt	92	95	97	97	80	82	84	85
Lumens per foot (305mm)	1097	1132	1155	1155	946	976	996	1005
Watts per foot (305mm)	12.0	12.0	12.0	12.0	12.0	12.0	12.0	12.0
<b>High Output (HO)</b>								
Efficacy - Lumens per Watt	85	88	90	90	74	76	78	78
Lumens per foot (305mm)	2084	2150	2194	2194	1797	1854	1891	1910
Watts per foot (305mm)	24.6	24.6	24.6	24.6	24.6	24.6	24.6	24.6

© 2019 Vode Lighting LLC. All rights reserved.

The Vode logo and Vode, DoubleBox and Zipper Board names are either registered trademarks or trademarks of Vode Lighting LLC in the United States and/or other countries. All other brand or product names are trademarks or registered trademarks of their respective owners. Due to ongoing innovation, specifications may change without notice.

Vode Lighting LLC | 21684 Eighth Street East, Suite 700, Sonoma, CA 95476 | 707.996.9898